

a部詳細

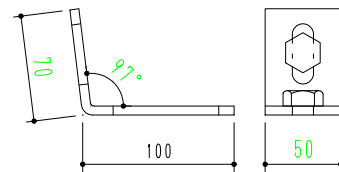

(FB-6t×50×170)

b部詳細

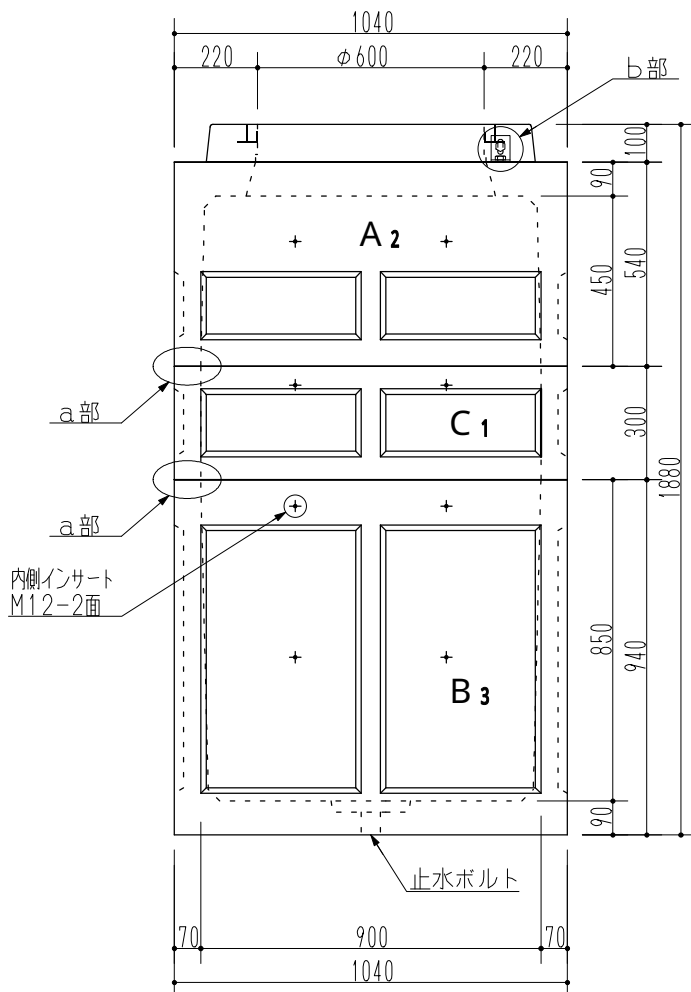
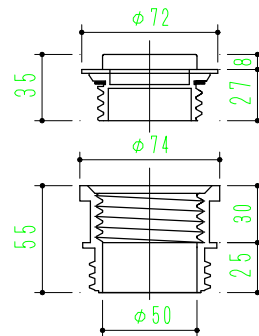

止水ボルト詳細

参考重量 1440kg

品名承認	OK式ハンドホール				図面番号
	900×900×1600H				
検図	設計	縮尺	1/20	0916-2	
フジプレコン株式会社					