

a部詳細

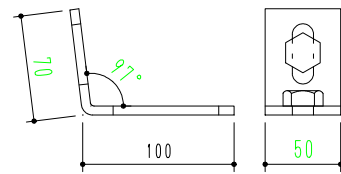

(FB-6t×50×170)

b部詳細

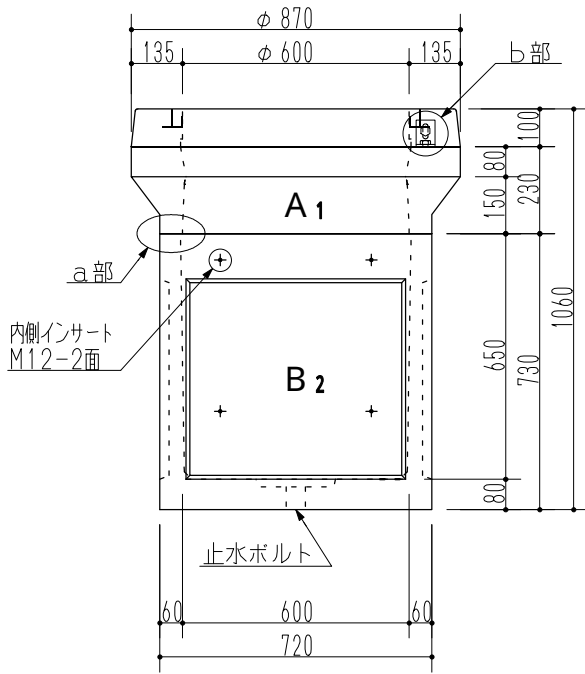
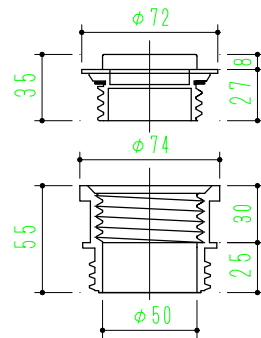

止水ボルト詳細

参考重量 616kg

品名 承認	OK式ハンドホール 600×600×800H				図面番号 0608
	検 図	設 計	縮 尺	1 20	
フジプレコン株式会社					